

**KOSS**  
INDUSTRIAL, INC.



## Cookers

Safety, Basic Part Assembly,  
Drawing Reference Manual





## Your Equipment:

..... serial number

..... description

..... equipment location

..... components

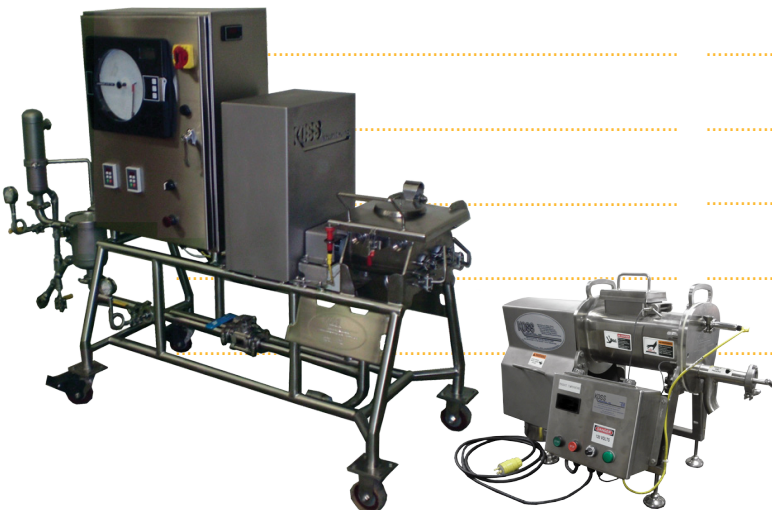

## Table of Contents

INTRODUCTION ..... manual  
 ..... label  
 1 RECEIPT ..... receiving  
 ..... set-up  
 ..... transport  
 2 FAMILIARIZATION ..... equipment function  
 ..... parameters  
 ..... start-up/cleaning  
 ..... pre-operation checks  
 ..... discharge doors  
 ..... sample ports  
 ..... seals  
 ..... steam system  
 ..... auger removal  
 ..... jack up auger  
 ..... teflon re-coating  
 3 UTILITIES ..... electrical  
 ..... fuse replacement  
 ..... electric motor  
 ..... compressed air  
 ..... steam supply

## Table of Contents

4	SAFETY .....	.....labels
		.....lock out/tag out
		.....ppe (personal protective equipment)
		.....maintenance schedules
		.....training
		.....recordkeeping
5	OPERATION .....	
		.....panel door operations
		.....screen operations
6	MAINTENANCE & SERVICE .....	
		.....recommended spares
		.....troubleshooting



**This unit is to be operated by authorized personnel only. All operators and maintenance personnel MUST read this publication in its entirety before energizing this equipment.**

## Manual

This manual is assembled to aid the operator and maintenance personnel in the familiarization of the equipment and safety instruction. This manual applies to Koss Cookers; available in a variety of capacities and configurations, expect variations within due to the highly customized nature of these units. All industry standard safety practices set forth by OSHA and NFPA must be followed by operators and qualified maintenance personnel when working on or with this equipment.

Information provided herein is based upon the standard production line and lab sized equipment.

Have this manual (and any other applicable documents) available at the unit's operating site, ensure that personnel read and follow the instructions within. Observe any additional rules and regulations referring to the equipment.

## Label

Your equipment has been shipped with a permanent stainless steel label for identification purposes. If this booklet is lost, the label will provide the information necessary to identify the equipment and any replacement parts.

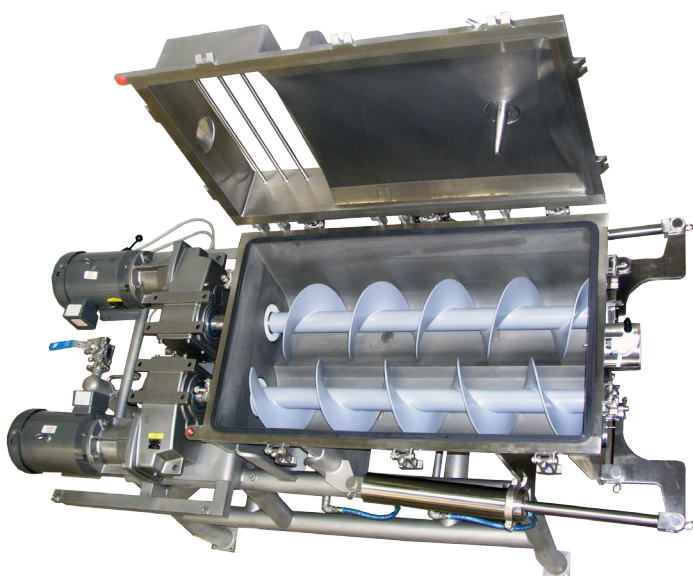

## RECEIPT 1

### Receiving

Upon receipt of the package from the common carrier, all components should be securely mounted to the crate with no visible damage. If a component has broken loose or the skid is damaged, check for component damage. If damage is evident, open the package immediately and check contents. If damage is evident notify the carrier for credit and Koss Industrial, Inc. for repair or replacement of the equipment.

If the package is damaged and no physical damage is apparent to the equipment, write on the carrier's paperwork "PACKAGE DAMAGED" to protect your rights to collect for damage discovered in the future/ at startup.

**Note:** KOSS INDUSTRIAL, INC. WILL ONLY REPAIR OR REPLACE DAMAGED GOODS FREE TO THE CUSTOMER FOR MATERIAL REIMBURSED BY THE CARRIER

### Set-up

Move the equipment to its final location, be very careful as it could easily be damaged from even a short fall. Once in place, level the Cooker with consideration for proper drainage. It is very important that the equipment is level, as it may not run as well without leveling.

- Re-assemble any sections/components removed from equipment for shipment
- Verify that utilities are piped to the unit and all steam & condensate lines are insulated for energy conservation and to protect personnel from hot surfaces
- Hook up all applicable utilities; electrical, steam, air, water (to be done by qualified personnel)

### Transport

Cookers with casters may be moved WHEN AT ROOM TEMPERATURE (with adherence to all applicable rules and regulations) to different locations within a facility provided that ALL CASTERS ARE LOCKED PRIOR TO UTILITY CONNECTION/OPERATION.

If your equipment does not have casters, then it is NOT portable and can NOT be moved to different locations within a facility. Contact Koss Industrial for information and/or assistance if moving this equipment to a different location.

## FAMILIARIZATION 2

Koss' Electrical Department offers a touch screen operator interface (push button available), it is used to edit recipes and control equipment operation. Controls can be programmed to offer multiple recipes' steps, ensuring consistency by reducing human input. Utilize batch control; it organizes activities/functions specifically, ensuring consistency. If equipment is part of a larger production line, Koss offers production line automation services.

When Koss Product Line Automation Services are included: we provide one main control panel and a separate high voltage panel (helps keep PLC cool & promotes safety by reducing unnecessary exposure to higher voltage. Touch screen operations enable the inclusion of safety features in the programming. It is ideal for use in a production line as it is a 'user friendly' interface. Operators are able to easily navigate the production line and its individual machines. With an image of the machine accompanying its specific controls, precision is easier than ever.

For equipment with controls, an Emergency Stop button is located on the main panel, which stops all operation and equipment is de-energized. When the button is depressed, it will display a red indicator. The unit is re-energized when the button is pulled out. Operation can then be re-started on the operators interface screen.

### Equipment Function

This equipment is designed to your, the customer's, application and specifications.

For cookers designed to clean in place without disassembly: Clean-in-Place (CIP) - The removal of soil from product contact surfaces in their process position by circulating, spraying or flowing chemical solutions and water rinses onto and over the surfaces to be cleaned.

Ensure that equipment components that are not CIP-able are removed to be COP or manually cleaned.

Please observe all warning labels as displayed on and around the main control panel. They are there for your protection. See Lockout/Tag out section of this manual.

### Parameters

Koss machines are custom designed and engineered to operate within specific parameters ideal for the customer's intended application (parameters considering variables such as temperature, viscosity, etc.). Using the machine for an application other than that which was specified, and documented, may result in direct/latent damages. Running a product outside of the intended application's parameters may result in direct/latent damages to the machine and/or its parts and components.

Koss Industrial, Inc. is not liable for damages that occur during, or as a result of, improper use/operation of the machine (see start up/cleaning) and/or running a product other than that which was specified, and documented, for the quoting and design/engineering of the machine.

## Start-up/Cleaning

Review manual and become familiar with the machine prior to use—

Additionally, anyone who operates this machine must first review the manual and familiarize themselves with the machine and its operating parameters to prevent potential damages/safety hazards from improper use. If training was requested/given on the machine, be sure to train future/current personnel who will operate the machine.

- Remove / wash all gaskets
- Rinse / wash the machine thoroughly (ensure all contaminants from fabrication are removed)
- Replace all gaskets
- Make sure the unit is properly cleaned (follow cleaning procedures)

Ensure that regular cleaning maintenance is performed; following all applicable rules and regulations.

## Pre-Operation Checks

This machine is designed to operate efficiently with proper maintenance. However, each machine should be checked over thoroughly before operation and periodically during operation.

The following (applicable) items should be checked:

- Guarding is in place and properly secured
- Cover is secure with clamps at proper tension
- Condition of all welds
- Condition of piping (no cracks/proper tension on clamps)
- Condition of steam bundle (no cracks/clamped securely)
- Electrical wiring is not running through critical areas (over steam bundle/etc)
- Ensure that control panel is operational

If you have any questions concerning these guidelines, please call the Koss Industrial Technical Department at (920) 469-5300.



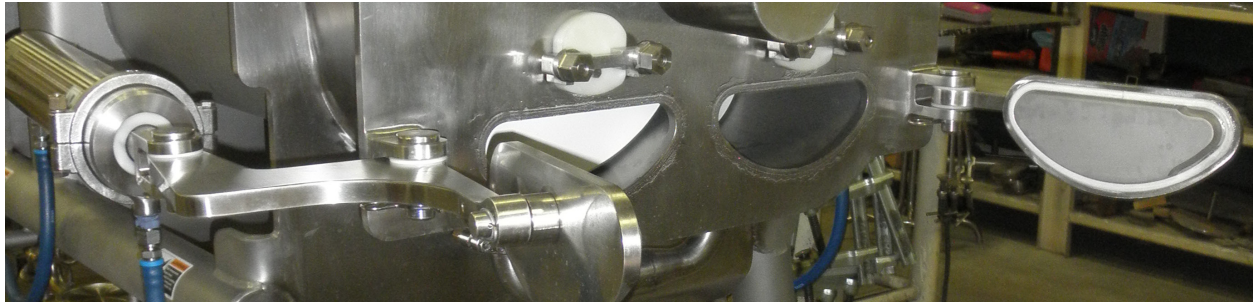

## Discharge Doors

Discharge doors provide positive drain out of the vessel. They are designed to allow the maximum amount of product out in the least amount of time.

The doors are made from solid stainless steel to provide a clean, durable design. They have an O-ring to give a positive seal when in the closed position.

### MANUAL DOORS

Doors are held shut by a positive locking latch designed for single-hand operation. The positive locking latch prevents leakage, allowing for maximum pressure on the doors.

### PNEUMATIC DOORS

The doors are opened and closed via air actuators and are pre-aligned and adjusted at Koss Industrial to ensure a tight seal is made when closed. There is an adjustment screw on the actuator arm if re-alignment is needed.

## Sample Ports

Sample ports are designed to provide a directed flow for taking samples of the product. The door is held shut by locking tabs. To open, rotate handle until inner locking tab aligns with keyhole opening (see bottom-right image), then pull straight back.

The plug has a two position o-ring seal to prevent product from coming out towards the handle.

**Note:** If leakage occurs, replace the sample port's o-rings.

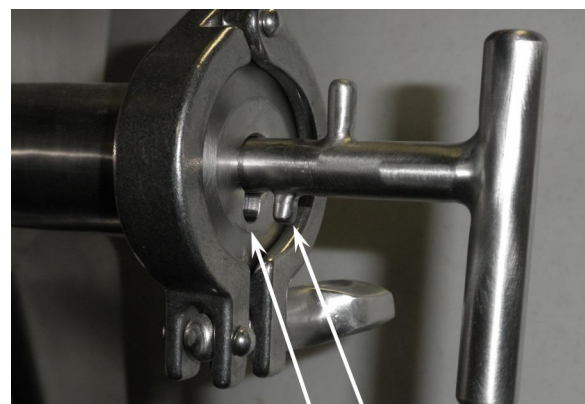

## Seals

There are two seals per auger on your cooker (2 seals on a single screw cooker, 4 seals on a twin). These seals keep the product you are cooking inside of the equipment. (images show location of front and rear seals on cooker)

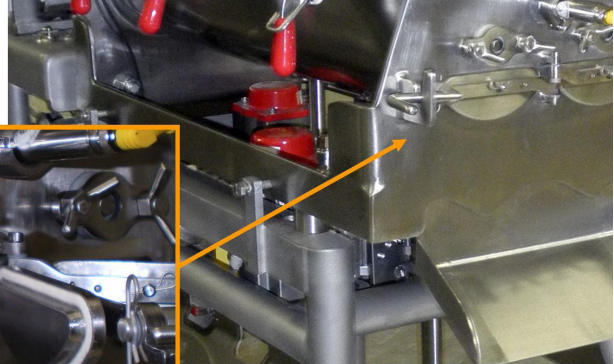
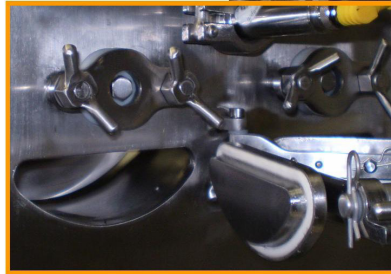

## Steam System

Poppit valves are designed & manufactured by Koss!

The images below are from a lab-sized, 3549 series:

- disassembled poppit vave



If you have any questions, please call the Koss Industrial Technical Department at (920) 469-5300.



## Auger Removal

These steps are to be followed very carefully or premature wear, poor performance and/or damage will occur. Do not attempt to skip steps in this section. Koss Industrial will not be responsible for damages or performance problems due to improper auger and drive placement.

Lockout/tagout the machine per your standard in-house practices. Cooker body and augers must be cooled down to room temperature before attempting to disassemble. Failure to do so can result in damage to components/personnel.

**Note:** An overhead crane/mechanical lifting device is recommended for the auger to avoid injury

**Follow these steps for auger removal** (images on right):

1. Slide piece of plastic scrap under augers to prevent scratching
2. Remove motor and gearbox (see “Jack Up Auger” information on following page for larger sizes, i.e. 18T Cookers!)
3. Remove nuts, auger support weldment, heavy duty auger front bushing (in order)
4. Remove rear seal
5. Lift augers from discharge ends until flights clear front plate
6. Slide augers forward until journal clears rear plate, Lift Clear
7. Follow these steps in reverse to re-insert the augers.

**Note:** For augers with matching drive stub shafts - the auger assemblies may be placed in either position but must be mated with it's proper drive shaft. The ends of each shaft are stamped with either an “L” or an “R”.

If you have any questions concerning these guidelines, please call the Koss Industrial Technical Department at (920) 469-5300.

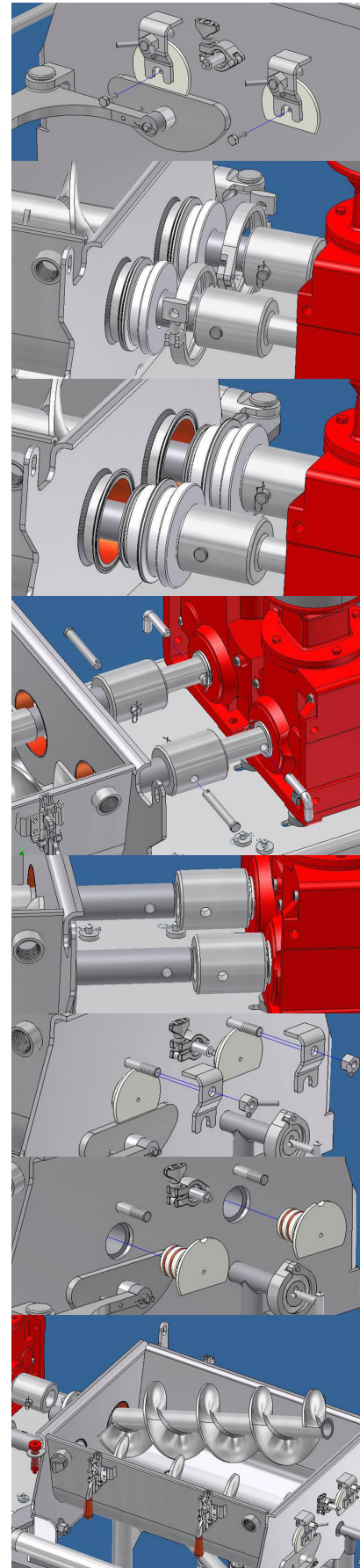



## Jack Up Auger (step 2, auger removal)

**Information applicable for some larger sizes (i.e. 18T Cookers).**

Jack braces auger (to allow coupling movement). Jack located on frame. Align dowel pins (bottom of jack) with holes in C-channel (below drive shaft coupling). Once dowel pins are in place, rotate threaded jack-coupling until tightened by hand. Remove Jack once drive shaft coupling is recessed. Proceed to step 3 of Auger Removal (previous page)

**Note:** Reference images below

If you have any questions concerning these guidelines, please call the Koss Industrial Technical Department at (920) 469-5300.

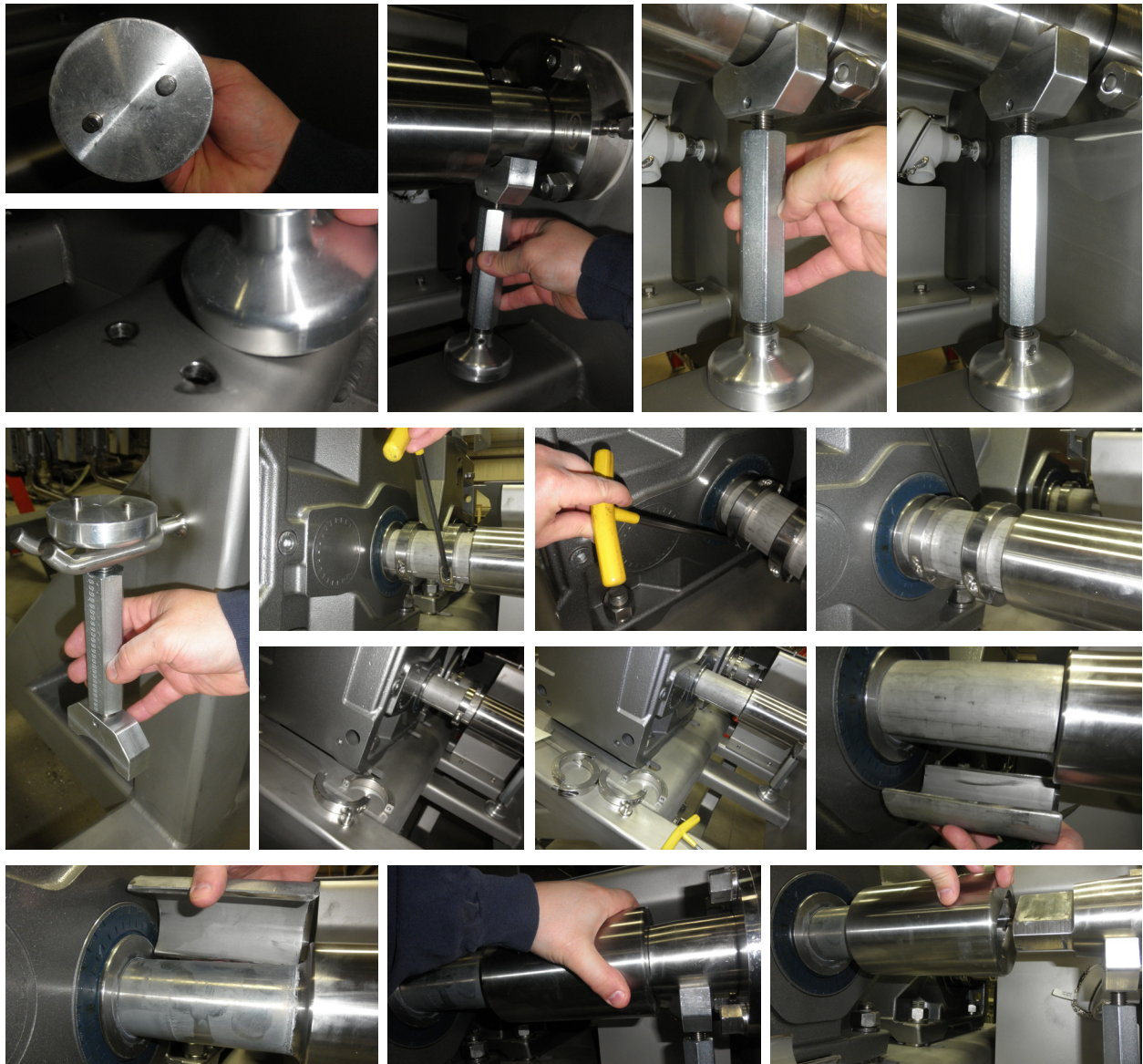



## Teflon Re-Coating

Since augers are hollow, a hole must be re-drilled into the end to safely allow expansion during the re-coating process. The hole drilled into the auger's end must be re-welded (sealed) prior to using the auger.

### **IMPORTANT NOTICE**

**PRIOR TO RE-COATING** an auger with teflon, you must **RE-DRILL A HOLE** in the end.

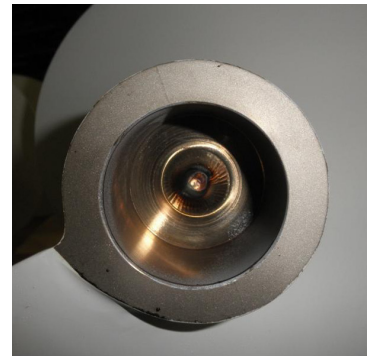
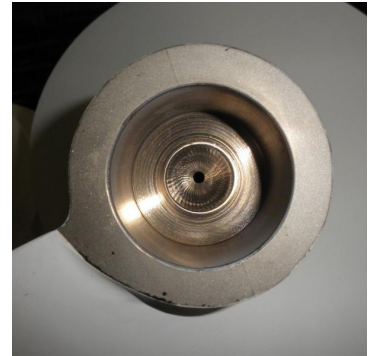

## UTILITIES 3

Koss Cookers are designed to operate with the following plant facility utilities (when applicable):

**Note:** Numbers are approximations and will vary based upon equipment size/customizations; exact values must be found testing with application in field. Information provided is based upon standard Lab & Line-Sized equipment (also R&D-Sized when specified).

### Electrical

This system is designed with circuit breakers for equipment and personal protection. If a circuit breaker is tripped you must contact qualified personnel to troubleshoot and correcting any possible problems before resetting the circuit breaker.

- Power Requirements: R&D-Size: 120 Volts AC @ min 5 amps (standard duplex receptacle)

### Fuse Replacement

All electric power shall be removed from the equipment as described in the Lockout / Tag out section of this manual. Fuse replacement must be performed by authorized personnel ONLY! Determine which fuse shall be replaced, using a fuse puller remove the fuse from its mounting block. Using the proper replacement fuse insert the new fuse into the block. Ensure that the fuse is secure and fits snug in the holder.

- Use an exact replacement, never compromise the voltage and amperage rating when replacing a fuse. Never use copper/metal tube or pipe as a replacement conductor. Energize the system using proper safety procedures.

### Electrical Motor

Koss Industrial Inc. is supplying an electric motor(s) sized for your equipment / application (single-screw models - 1 motor, twin - 2). Motors' permanent labels & Cooker drawings provide technical specifications.

- Motor starters, additional safety switches & controls are to be supplied by the customer (unless optional control package is included)
- Unit to be wired by a qualified electrician—all local and state codes must be followed.

### Compressed Air

For cookers with pneumatically controlled covers / discharge doors - connection(s) are located at the bottom of the main enclosure, or at the rear of the machine (for models without a mounted panel).

- NPT supply line is required to connect compressed air
- Recommended pressure, uninterrupted air supply: Lab-Size: 70 psi, Line-Size: 90 psi

### Steam Supply

- Port(s) provided for steam line connection
- Recommended: R&D/Lab-Size min: 15 psi (25 lb/hr), Lab/Line-Size min: 50 psi (500 lb/hr)

## Safety 4

### Labels

Equipment comes with labels warning of the dangers which may result from inappropriate handling/operation. Be aware of potential dangers including (but not limited to): pinch points, entanglement and burning (from steam/hot surfaces). If any labels are lost or missing please call the Koss Industrial Technical Department at (920) 469-5300. Ensure that all warning labels are in place and visible!

Before any maintenance or adjustment work is performed on this machine, contents must be removed; also, all power and potential energy must be shut off, locked out, and bled off. Machine must be cooled down prior to any maintenance/adjustment work. Failure to follow guidelines may result in injury or death.

### Lock Out / Tag Out

Before performing any maintenance on the machine disconnect the power source from the drive motor(s) and follow your company's Lock out Tag out procedures. ALL OF YOUR COMPANY LOCKOUT / TAGOUT RULES AND REQUIREMENTS SUPERCEDE THIS DOCUMENT, WHICH IS A GENERAL GUIDELINE.

Certain models are provided with a main power disconnect means and can be locked out for safety.

Electrical power must be removed when electrical equipment is inspected, serviced or repaired; to ensure the safety of personnel working with the equipment, remove power and lock out/tag out equipment.

Per OSHA standards, equipment is locked out and tagged out before any preventive maintenance or servicing is performed. Lockout is the process of removing the source of electrical power and installing a lock which prevents the power from being turned ON. Tagout is the process of placing a danger tag on the source of electrical power which indicates that the equipment may not be operated until the danger tag is removed. See Figure 1-2 (following page).

A danger tag has the same importance and purpose as a lock and is used alone only when a lock does not fit the disconnect device. The danger tag shall be attached at the disconnect device with a tag tie or equivalent and shall have space for the worker's name, craft, and other required information. A danger tag must withstand the elements and expected atmosphere for as long as the tag remains in place. A lockout/tagout is used when:

- Servicing electrical equipment that does not require power to be ON to perform the service
- Removing or bypassing a safety device.
- The possibility exists of being injured.
- The danger exists of being injured if equipment power is turned ON.



Figure 1-2

Equipment must be locked out and tagged out before preventive maintenance or servicing is performed.

Lockouts and tagouts do not by themselves remove power from a circuit. An approved procedure is followed when applying a lockout/tagout. Lockouts and tagouts are attached only after the equipment is turned OFF and tested to ensure that power is OFF. The lockout/tagout procedure is required for the safety of workers due to modern equipment hazards. OSHA provides a standard procedure for equipment lockout/tagout.

OSHA's procedure is:

1. Prepare for system shutdown
2. System or equipment shutdown
3. System or equipment isolation
4. Lockout or tagout application
5. Release of stored energy
6. Verification of isolation

Notice: Personnel should consult OSHA Standard 29CFR1910.147 for industry standards on lockout/tagout.

A lockout/tagout shall not be removed by any person other than the person that installed it, except in an emergency. In an emergency, the lockout/tagout may be removed only by authorized personnel. The authorized personnel shall follow approved procedures. A list of company rules and procedures are given to any person that may use a lockout/tagout.

Always remember:

- Use a lockout and tagout when possible
- Use a tagout when a lockout is impractical. A tagout is used alone only when a lock does not fit the disconnect device
- Use a multiple lockout when individual employee lockout of equipment is impractical
- Notify all employees affected before using a lockout/tagout
- Remove all power sources including primary and secondary
- Measure for voltage using a voltmeter to ensure that power is OFF



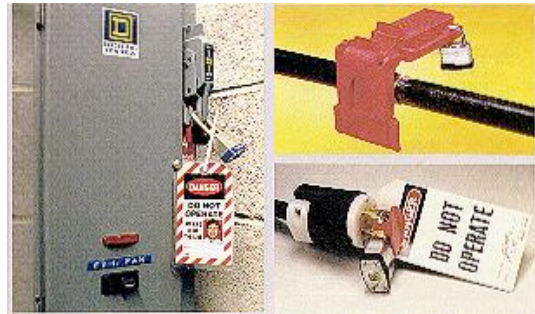

Figure 1-3

Lockout devices are available in various shapes and sizes that allow for the lockout of standard control devices.

Lockout devices are lightweight enclosures that allow the lockout of standard control devices. Lockout devices are available in various shapes and sizes that allow for the lockout of ball valves, gate valves, and electrical equipment such as plugs, disconnects, etc.

Lockout devices resist chemicals, cracking, abrasion, and temperature changes. They are available in colors to match ANSI pipe colors. Lockout devices are sized to fit standard industry control device sizes. See Figure 1-3.

Locks used to lock out a device may be color coded and individually keyed. The locks are rust-resistant and are available with various size shackles.

Danger tags provide additional lockout and warning information. Various danger tags are available. Danger tags may include warnings such as “Do Not Start,” “Do Not Operate,” or may provide space to enter worker, date, and lockout reason information. Tag ties must be strong enough to prevent accidental removal and must be self-locking and non-reusable.

Lockout/tagout kits are also available. A lockout/tagout kit contains items required to comply with the OSHA lockout/tagout standards. Lockout/tagout kits contain reusable danger tags, tag ties, multiple lockouts, locks, magnetic signs, and information on lockout/tagout procedures. See Figure 1-4. Be sure the source of electricity remains open or disconnected when returning to work whenever leaving a job for any reason or whenever the job cannot be completed the same day.

Figure 1-4

Lockout/tagout kits comply with OSHA lockout/tagout standards.

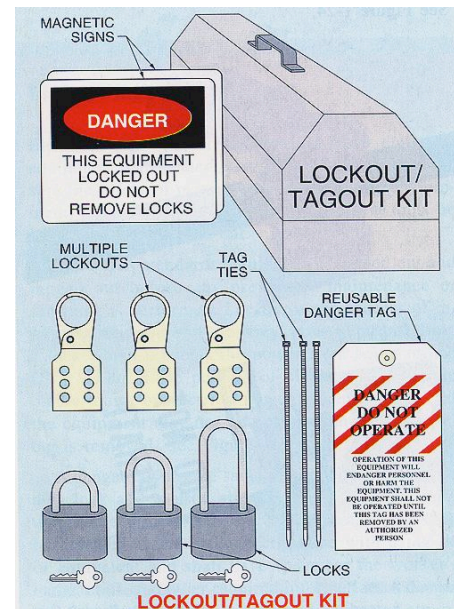

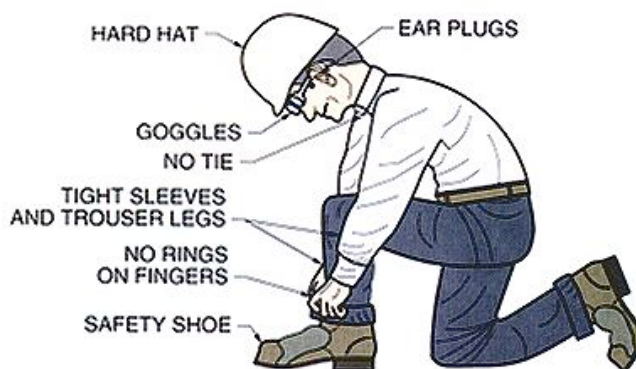

Figure 1-26

Clothing should fit snugly to avoid danger of becoming entangled in moving machinery or creating a tripping or stumbling hazard.

## PPE (Personal Protective Equipment)

This equipment utilizes chemicals for the cleaning process. Safety must be exercised at all times. Anyone handling chemicals must use personal protective equipment (PPE) and follow strict procedures.

All personal protective equipment (PPE) shall be provided, utilized and maintained in a sanitary and reliable condition whenever deemed necessary by reason of hazards, processes or environment.

This policy applies to all employees who by nature when using this equipment have the potential to be exposed chemical or physical hazards which can cause illness, injury or impairment to any part of the body through absorption, inhalation, or physical contact.

### OPERATORS/MAINTENANCE PERSONNEL RESPONSIBILITY:

- Ensuring PPE is available;
- Providing PPE as required;
- Providing PPE as required or upon request to all employees;
- Ensuring PPE is being used by each affected employee during all job tasks which require such protection;
- Conducting specific hazard assessments for personal protective equipment use upon request;
- Documenting purchase and distribution of all PPE; and
- Taking the appropriate corrective action in accordance with the Hormel Foods policies.
- Assessing the workplace to determine if hazards are present, or are likely to be present, which necessitate the use of PPE;
- Communicating selection decisions to each affected employee and supervisor;
- Selecting and recommending PPE that properly fits each affected employee;
- Providing training in the proper use and care of PPE; and
- Documenting aforementioned hazard assessment components.
- Inspecting all PPE prior to its use;
- Wearing PPE upon the direction of their immediate supervisor;
- Participating in mandatory training;
- Notifying their supervisor when new PPE is necessary;
- Contacting Environmental Health and Safety when a hazard or process has changed which may render previously used PPE ineffective; and
- Notifying their supervisor of any changes which might impact the type of PPE they utilize.

**CONSIDERATIONS:**

PPE devices alone shall not be relied on to provide protection against hazards, but shall be used in conjunction with guards, engineering controls, administration controls and sound manufacturing practices.

When selecting PPE, utilize the following considerations as a basic directive.

- Application: What part of the body is being protected?
- Chemical Resistance: Will material maintain its structural integrity and protective qualities?
- Strength: Is the material resistant to punctures, tears, and abrasions?
- Flexibility: Does PPE provide the necessary dexterity?
- Thermal Limits: Does clothing maintain its mobility and protective capacity in temperature extremes?
- Cleanable: Can material be easily cleaned and reused?
- Longevity: Will clothing resist aging?

**HAND PROTECTION:**

Hand protection shall be worn when hands are exposed to hazards such as those from skin absorption of harmful substances, severe cuts or lacerations, severe abrasions, punctures, chemical burns, thermal burns and harmful temperature extremes.

The type of hand protection used shall be based on the performance characteristics of the hand protection relative to the task(s) to be performed, conditions present, duration of use, and the hazards or potential hazards identified.

With respect to selection of gloves for protection against chemical hazards

- The toxic properties of the chemical(s) must be determined; in particular, the ability of the chemical to cause local effects on the skin and/or to pass through the skin and cause systemic effects
- Generally, any "chemical resistant" glove can be used for dry powders
- For mixtures and formulated products (unless specific test data are available), a glove shall be selected on the basis of the chemical component with the shortest breakthrough time, since it is possible for solvents to carry active ingredients through polymeric (a chemical compound or mixture of compounds formed by polymerization and consisting essentially of repeating structural units) materials
- Employees shall be able to remove the gloves in such a manner as to prevent skin contamination

Gloves shall be removed before touching public objects such as telephones, elevator buttons, or door handles to avoid cross contamination.

**EYE/FACE PROTECTION:**

Suitable eye protection or face protection shall be worn when there is the potential for exposure to the eyes or face from flying particles, chemicals, gases or potentially hazardous vapors. Side protection is required when there is a hazard potential from flying objects. Detachable side protectors (e.g., clip-on or slide-on shields) meeting the pertinent requirements are acceptable.

Eye protection shall be durable, comfortable and easy to clean. Persons whose vision requires the use of corrective lenses and who by nature of their job duties require eye protection shall wear goggles or a full face shield that can be worn over the prescription lenses.

There are four general classes of eye and face protection: safety glasses, face shields, goggles and welding helmets. The type of protection required shall be determined by the type and degree of the hazard and shall comply with ANSI Z87.1-1989 "American National Standard Practice for Occupational and Educational Eye and Face Protection".

**FOOT PROTECTION:**

This equipment is portable and safety must be used when transporting this equipment. Foot protection shall be worn when there is the potential for injury to the feet from falling or rolling objects, objects piercing the sole of the foot, electrical hazards, hot surfaces and slippery surfaces.

Foot protection shall comply with ANSI Z41-1991 "American National Standard for Personal Protection - Protective Footwear".

**HEARING PROTECTION:**

Use of hearing protection shall be provided and used in accordance with the Hormel Foods Hearing Protection policies.



#### BODY PROTECTION:

Full body protection shall be worn when there is a potential for contamination or exposure to other parts of the body (e.g., legs, arms, back, chest) from heat, splashes from liquids, impacts, cuts, and chemicals.

Body protection includes the following:

- Lab coats
- Boot covers
- Aprons
- Bouffant caps
- Tyvek suits and Coveralls

#### ELECTRICAL PROTECTIVE DEVICES:

This equipment is provided with a means of Lockout/Tag out for the electrical power provisions. Anyone performing adjustments or maintenance to his equipment must follow all Industry Standard Lockout/ Tag out procedures. If a circuit breaker is tripped you must contact qualified personnel to troubleshoot and correcting any possible problems before resetting the circuit breaker. See Lockout/Tag out section.

### Maintenance Schedules

PPE shall be inspected, cleaned and maintained by employees at regular intervals so it can be discarded, changed and/or decontaminated as deemed necessary. At a minimum, all PPE shall be discarded when it has become contaminated, worn, torn or has other integrity problems.

It is important to ensure that contaminated PPE which cannot be decontaminated is disposed in a manner that protects employees from exposure to hazards while ensuring compliance with appropriate regulations.

Note: Inspect PPE before each use for tears, punctures, holes, cuts, cracks, embedded foreign objects and texture changes (e.g., swelling, softening, hardening, becoming sticky or inelastic).

## Training

Initial training shall be provided by your Environmental Health and Safety or the appropriate department for each employee who is required to use PPE. This training shall utilize the "Personal Protective Equipment" training booklet generated by Environmental Health and Safety which shall be updated to ensure consistency with changes in protective equipment and work processes.

Each employee shall be trained in at least the following:

- When PPE is necessary;
- What PPE is necessary;
- How to properly don, doff, adjust, and wear PPE;
- The limitations of the PPE; and
- The proper care, maintenance, useful life and disposal of the PPE.

Each affected employee shall demonstrate an understanding of the aforementioned training and the ability to use PPE properly before being allowed to perform work requiring the use of PPE.

### RETRAINING

When there is reason to believe that any affected employee who has already been trained does not have the understanding and skill as required above, Environmental Health and Safety or the affected department shall retrain each such employee.

Circumstances where retraining is required include, but are not limited to, situations where:

- Changes in the workplace render previous training obsolete;
- Changes in the types of PPE to be used render previous training obsolete; or
- Inadequacies in an affected employee's knowledge or use of assigned PPE indicate that the employee has not retained the requisite understanding or skill.

## Recordkeeping

Environmental Health and Safety shall verify that each affected employee has received and understood the required training through a written certification containing the name of each employee trained, the date(s) of training and the subject of the certification

## OPERATION 5

### Panel Door Operations

For Cooker models with controls on unit, the speed, rotation, start and stop of the screws are controlled from the panel box door. Two rectangular displays (lower left corner): run auger(s) direction and speed

- Ensure panel box door handle is in the down position and the safety lockout handle is in the on position
- Pull out emergency stop button
- Turn 3 position auger control switch to desired position, Press green button on each panel to start
- Set desired temperature on chart recorder
- Turn 3 position steam control switch to desired position

**Note:** Lab units intended for short use (not production) thus do not have cycle start

### Touchscreen Operations

#### PRODUCTION LINE AUTOMATION

Touchscreen operation is an available feature used for automation of the entire production line, controlling & monitoring both the cooker and additional equipment within the line. Training provided at commission.

#### CONTACT

For more information on production line automation contact a team member at Koss Industrial.

Each automation solution is unique to customers' applications. Please direct questions regarding the operation of your customized touchscreen automation solution to your company's personnel who received training from Koss.

If a company would prefer additional training from Koss Industrial on the operation of their touchscreen user interface, please contact Koss representative.

## MAINTENANCE & SERVICE 6

No one is to perform any type of maintenance or adjustments to this equipment without authorization.

Only a trained electrician is to access the control enclosure; only after power has been disconnected as well as Lockout / Tag out & all company safety procedures have been followed.

Direct all questions regarding service & maintenance to the manufacturer of this equipment:

### **Koss Industrial, Inc.**

1943 Commercial Way  
Green Bay, WI 54311

phone (920) 469.5300  
toll free 1.800.844.6261

### Recommended Spares

Here at Koss Industrial there are items that we feel benefit the customer to have spares on-site. Although we stock a variety of items, the item you need may be currently out of stock and lead times vary based upon product/circumstance.

#### REFERENCE DRAWINGS/DOCUMENTS FOR EQUIPMENT SPECIFICATIONS AND PART NUMBERS

**Seal Kits** for all valves/cylinders

**Gear Boxes & Motors** for each different model/style

**Front & Rear Seals** for Cookers/Grinders/Other applicable equipment

**Sensors & Control Devices**

**Specialty Stainless Fittings**

**Any Unique Items** that may require a long lead time

We stock a wide variety of components & component parts, contact us for spares throughout your plant!  
Shop our Online Store - [www.StainlessSteelThings.com](http://www.StainlessSteelThings.com)



Highly customizable Koss Cookers provide optimal performance to complement unique applications.

Since ideal operating parameters are found in field, expect a familiarization period when first implementing your Koss Cooker.

During this introductory period, finding your ideal operating parameters: familiarize operating personnel with the equipment, and your equipment with your application for quality performance throughout the equipment's lifetime.

## Troubleshooting

Listed below are some of the most common questions/comments/concerns regarding Koss Cookers.

### **AIR BUBBLES IN CHEESE/PRODUCT**

Aeration of product becomes prevalent when the auger/vfd is operating at an increased speed/rate.

- To reduce product aeration the operator should lower the speed/rate, to find the ideal operating parameters for your application.
- If you prefer to continue operating the equipment at the same increased rate, but still want to reduce product aeration, a cheese vacuum system may be an ideal solution for your process/application.

### **EXCESSIVE CONDENSATE IN COOKER**

- May have failed steam trap on the header, filter or separator - allowing too much condensate into the cooker

### **LOSS OF STEAM PRESSURE**

- May result in longer cook times, poro carbon filter may be plugged

### **SHAKING OF COOKER**

During operation your equipment may experience varying levels of movement

- The movement may be dependent upon your cooker's configuration; for example, a larger model cooker with longer legs/increased height is more prone to movement due to its higher center of gravity than a lab sized cooker designed with shorter legs.
- Ensure that the equipment is level, this is especially important for models with adjustable feet; to ensure optimal performance, we recommend checking that your cooker is properly leveled.
- Larger or particularly hard (frozen) pieces of product may cause additional movement of the cooker; operator may try reducing auger speed; contact Koss for more information if your interested in learning about our trim/pre-breaking and grinder solutions (multiple screen sizes available for grinders).

### **EXCESSIVE SEAL WEAR**

- Shaking of cooker or excessive wear of seals may be caused because of wear or a bent auger
- Auger should be removed and inspected for straightness and concentricity (follow proper auger removal procedure described in section 2 of this reference manual, "Familiarization").

## Contact Koss

Koss Industrial, Inc.  
..... 1943 Commercial Way  
.....Green Bay, WI 54311

phone.....920.469.5300  
fax .....920.469.5319  
tollfree ..... 1.800.844.6261

email ..... info@KossIndustrial.com

web ..... www.KossIndustrial.com  
..... www.StainlessSteelThings.com

